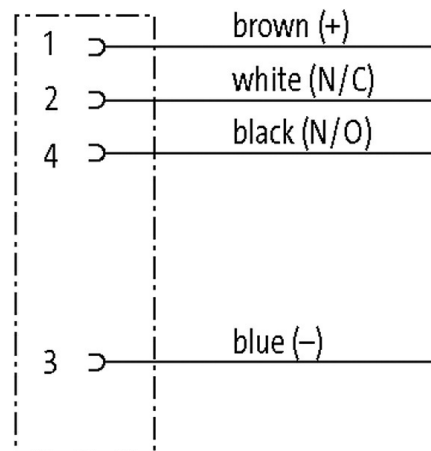
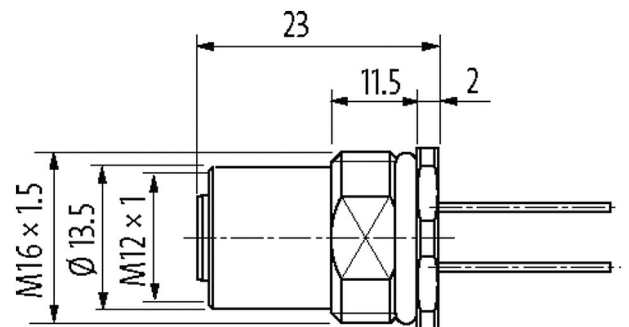

M12 FEMALE FLANGE PLUG A CODED REAR MOUNT

PP-wires 4X0.34 1.0m

Flange female
M12, 4-pole
Rear mounting
with multi-strand wire

Illustration

Product may differ from Image

Approvals

**Form**

Form 13545

Cables

Cable number	971
No./diameter of wires	4 × 0.34 mm ²
Wire isolation	PUR
Outer Ø	1.3 mm ±5%
Bend radius (fixed)	5 × outer Ø
Temperature range (fixed)	-40...+90 °C
Temperature range (mobile)	-25...+90 °C

Technical Data

Operating voltage	max. 250 V AC/DC
Rated surge voltage	2.5 kV
Operating current per contact	max. 4 A
No. of poles	4
Material group	IEC 60664-1, category I
Coding	A-coded
LED display	no
Locking of ports	Screw thread (M12×1 mm) recommended torque 0.6 Nm, self-securing
Compression gland	M12 (SW14)
Protection	IP67 inserted and tightened (EN 60529)
Protection NEMA	3, 4, 6P (UL 50E)
Material	Brass, nickel plated
Locking material	Brass, nickel plated
suitable for corrugated tube (internal Ø)	without

General data

Standards	DIN EN 61076-2-101 (M12)
Material (contact)	Copper alloy
Material (contact surface)	Au
Material (gasket)	FKM
Pollution Degree	3
Temperature range	-25...+85 °C

Commercial data

country of origin	DE
customs tariff number	85444290
EAN	4048879330008
eClass	27279220
Packaging unit	1

Sketch

stay connected

Female

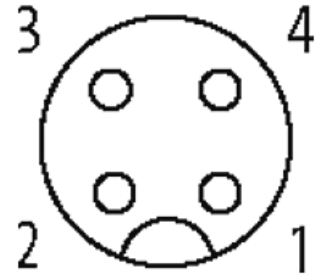

Product may differ from Image